



OPERATING INSTRUCTIONS

VHF DIGITAL/ANALOG TRANSCEIVERS
IC-F3200DEX
series

UHF DIGITAL/ANALOG TRANSCEIVERS
IC-F4200DEX
series

INTRODUCTION

1 ACCESSORIES

2 PANEL DESCRIPTION

3 BASIC OPERATION

4 dPMR™ OPERATION

5 SPEAKER MICROPHONE

INTRODUCTION

FOREWORD

Thank you for purchasing this Icom transceiver.
The IDAS™ dPMR™ system operation is built into your transceiver.

IMPORTANT

FIRST, CAREFULLY READ INSTRUCTIONS

① PRECAUTIONS and ② INSTRUCTIONS that are provided with the transceiver.

SAVE THIS OPERATING GUIDE— This operating guide contains additional important operating instructions for the IC-F3201DEX, IC-F3202DEX or IC-F3203DEX VHF DIGITAL/ANALOG TRANSCEIVERS and IC-F4201DEX, IC-F4202DEX or IC-F4203DEX UHF DIGITAL/ANALOG TRANSCEIVERS.

NOTE

To use in explosive atmospheres, read the leaflet “SAFETY MANUAL” comes with the transceiver.

Icom, Icom Inc. and the Icom logo are registered trademarks of Icom Incorporated (Japan) in Japan, the United States, the United Kingdom, Germany, France, Spain, Russia and/or other countries.

IDAS is trademark of Icom Incorporated (Japan).
dPMR and the dPMR logo are trademarks of the dPMR MoU Association.

All other products or brands are registered trademarks or trademarks of their respective holders.

Section 1 ACCESSORIES

Supplied accessories	1-2
Accessory attachments	1-3
◇ Flexible antenna	1-3
◇ Battery pack	1-3
◇ Belt clip.....	1-4
◇ Connector cover	1-4

Supplied accessories

The following accessories are supplied.

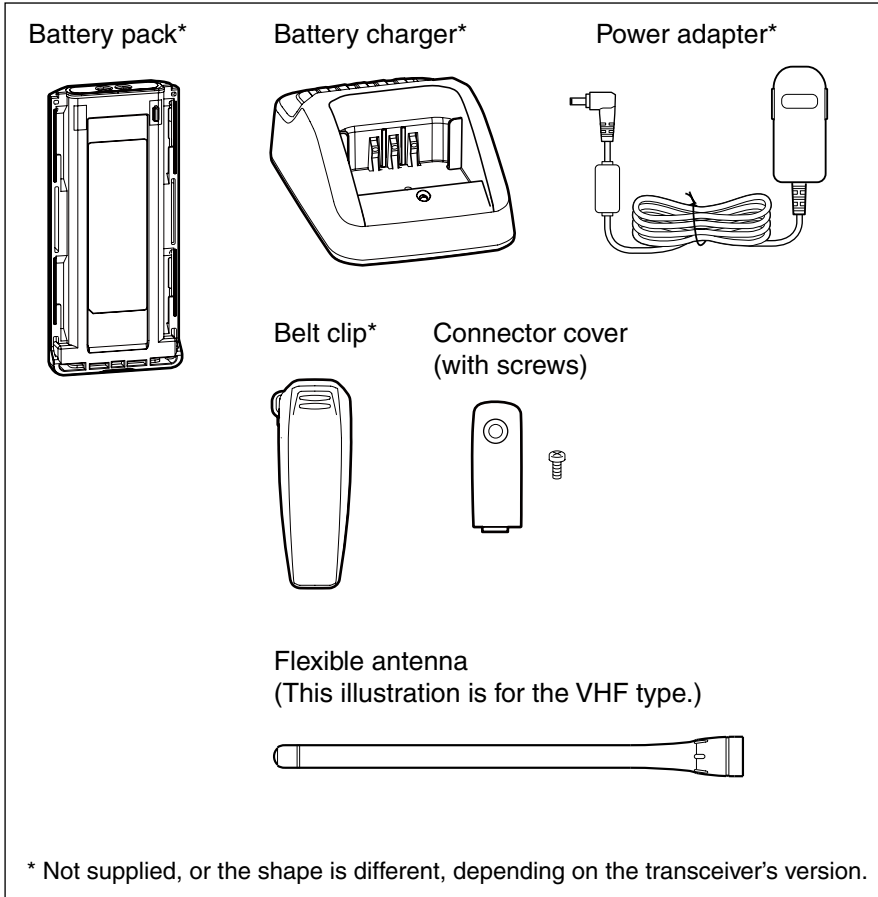

Accessory attachments

◇ Flexible antenna

Connect the supplied flexible antenna to the antenna connector.

CAUTION:

- **NEVER** carry the transceiver by holding only the antenna.
- **DO NOT** connect any antenna other than those listed on the basic instructions.
- Transmitting without an antenna will damage the transceiver.

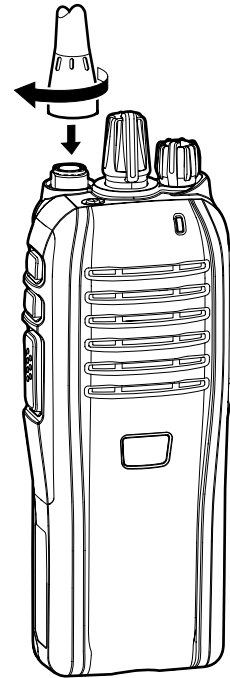

◇ Battery pack

To attach the battery pack:

Slide the battery pack on the back of the transceiver in the direction of the arrow (1), then lock it with the battery release button.

- Slide the battery pack until the battery release button makes a 'click' sound.

To remove the battery pack:

Push the battery release button in the direction of the arrow (2), as shown to the right. The battery pack is then released, and you can remove it.

NEVER remove or attach the battery pack when the transceiver is wet or soiled. This may result in water or dust getting into the transceiver/battery pack and may damage the transceiver.

NOTE: Keep the battery pack terminals clean. It's a good idea to occasionally clean them.

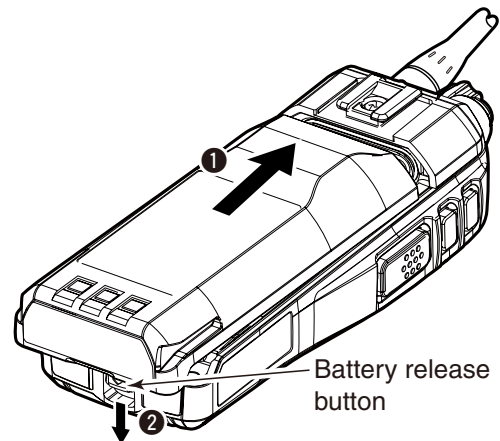

Accessory attachments (Continued)

◇ **Belt clip**

Before attaching or detaching the belt clip, remove the battery pack if it is attached.

To attach the belt clip:

➔ Slide the belt clip in the direction of the arrow until the belt clip locks and makes a 'click' sound.

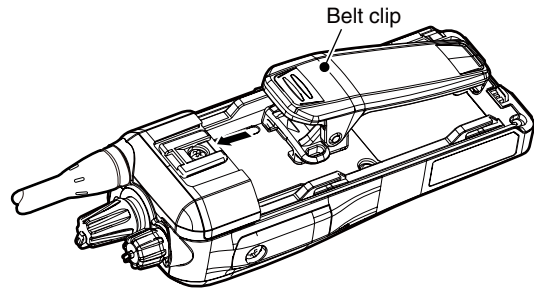

To detach the belt clip:

➔ Lift the tab up (1), and slide the belt clip in the direction of the arrow (2).

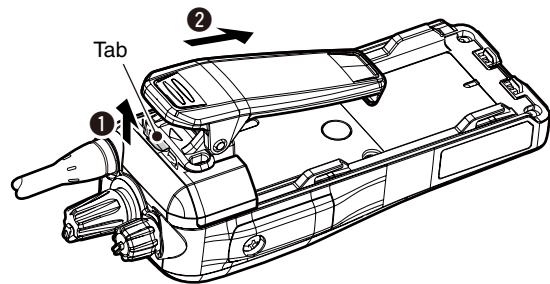

◇ **Connector cover**

To attach the connector cover:

- ① Place the connector cover over the multi-connector. (1)
- ② Tighten the screw. (2)

To detach the connector cover:

- ① Remove the screw using a Phillips screwdriver. (3)
- ② Detach the connector cover to connect optional equipment. (4)

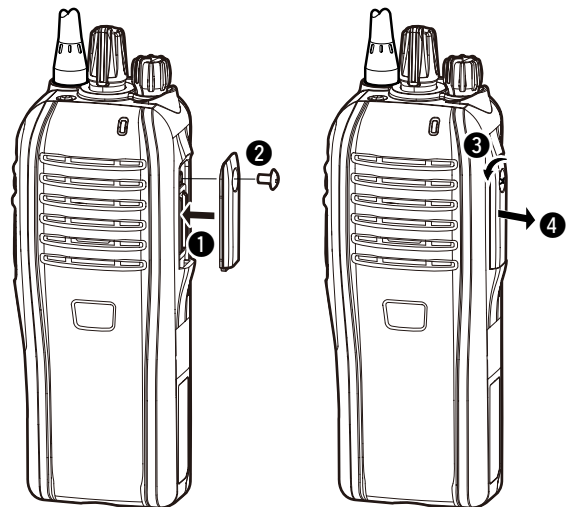

/// **CAUTION:**

Attach the connector cover when the optional accessory is not used. Otherwise, the terminals of the multi-connector may be shorted, and this could damage the transceiver.

Section 2

PANEL DESCRIPTION

Front, top and side panels	2-2
Status indicator	2-3
Programmable function keys	2-5

Front, top and side panels

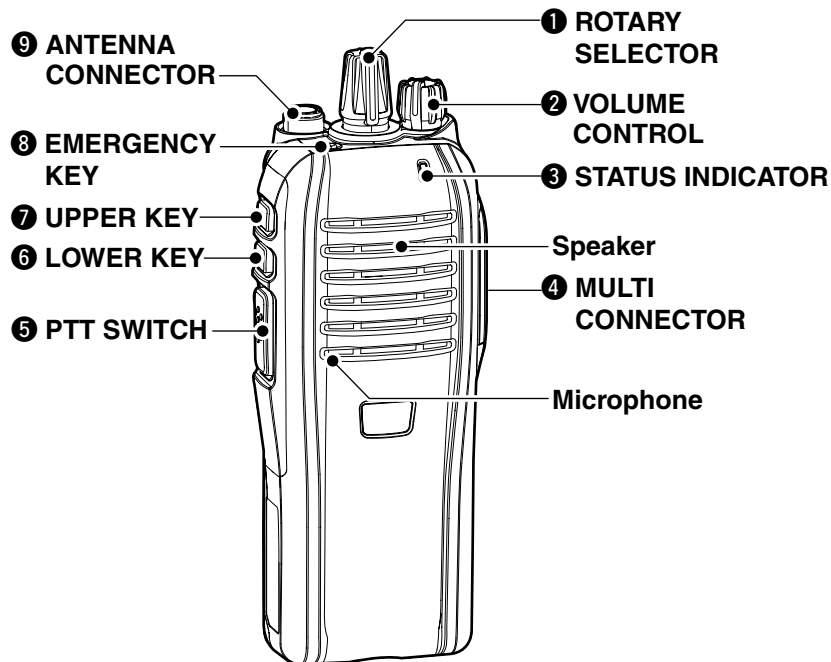

1 ROTARY SELECTOR

Rotate to select the preprogrammed memory channels or scan lists, depending on the preprogramming.

2 VOLUME CONTROL [VOL]

Rotate to turn the power ON or OFF, and adjust the audio level.

3 STATUS INDICATOR (pp. 2-3, 2-4)

- Lights red while transmitting.
- Lights green while receiving a signal, or when the squelch is open.
- Lights/blinks orange when the matched 2/5-tone code is received, depending on the presetting.

4 MULTI CONNECTOR

Connect optional accessory.

CAUTION:

Attach the connector cover when the optional accessory is not used. Otherwise, the terminals of the multi-connector may be shorted, and this could damage the transceiver.

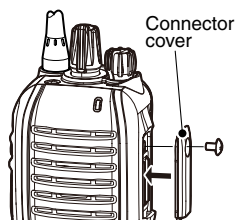

5 PTT SWITCH [PTT]

Hold down to transmit; release to receive.

6 LOWER KEY [Lower]

7 UPPER KEY [Upper]

Desired functions can be preset. (p. 2-5)

8 EMERGENCY KEY [Emer]

Desired functions can be preset. (p. 2-5)

9 ANTENNA CONNECTOR

Connect the antenna.

Status indicator

The status indicator indicates the various parameters of the transceiver as follows;
 (Reference: R is Red, G is Green, O is Orange)

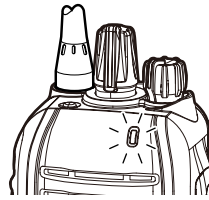

- TX:
Lights Red while transmitting.
- RX busy:
On an analog channel, lights Green when in the noise squelch opens.
On a digital or mixed channel, lights Green while detecting a frame synchronization.
- Call LED:
Turns ON when receiving a matched 2/5-tone, or receiving a Status or SDM (Short Data Message) call.
- Call LED:
Blinks when receiving a matched 2/5-tone, or receiving a Status or SDM (Short Data Message) call.
- Call LED:
Blinks while waiting for a return signal.
- Success:
Blinks slowly when your call was successful.
- Call error:
Blinks slowly when your call failed, or was refused.
- Audible:
Blinks slowly after a return signal is received when in the Audible mode*.
*Mute is released. (Received signal will be heard.)
- Fast, Slow or Voting scan:
Blinks when scanning for a channel to search for a signal.
- Low Battery 1:
You should charge the battery soon. (blinks slowly)
- Low Battery 2:
You must charge the battery. (blinks fast)
- TX low Battery 1:
Low Battery was detected in the TX mode.
- TX low Battery 2:
Very Low Battery was detected in the TX mode.

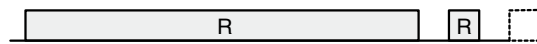
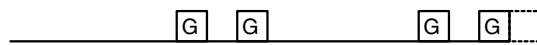
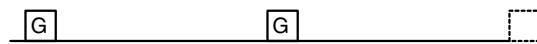
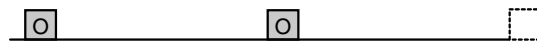
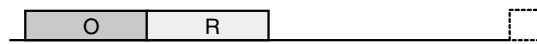
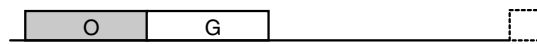
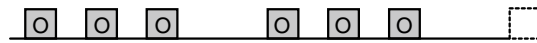
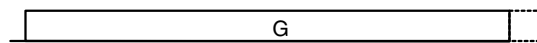

2 PANEL DESCRIPTION

Status indicator (Continued)

- Channel Error:
Blinks when a non-programmed channel is selected.



- Power ON:
Blinks at transceiver startup.



- TX inhibit:
Blinks while in the TX inhibit mode such as when the TOT or Lockout function is activated.



- Emergency:
Blinks when an Emergency call was received.



- Emergency Locator Ringer Siren:
Blinks while the Emergency locator, Ringer or Siren is activated.



Programmable function keys

The programmable key functions can be assigned to the [Upper], [Lower] and [Emer] programmable function keys.

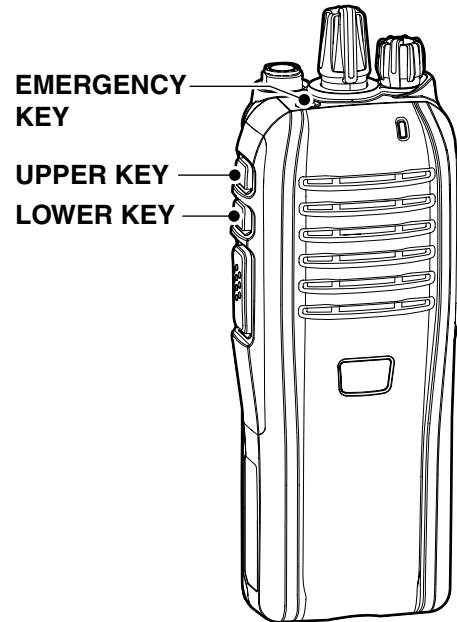

Programmable function keys (Continued)

The following functions can be assigned to the [Upper], [Lower] and [Emer] programmable function keys.

SCAN

Push to start and cancel scanning.

- When the scan started with the Power ON Scan or Auto Scan function, push to pause the scan. The paused scan resumes after the specified time period has passed.

PRIORITY A CHANNEL, PRIORITY B CHANNEL

Push to select the Priority A or Priority B channel.

PRIORITY A CHANNEL (REWRITE), PRIORITY B CHANNEL (REWRITE)

- ➔ Push to select the Priority A or Priority B channel.
- ➔ Hold down [Prio A (Rewrite)] or [Prio B (Rewrite)] for 1 second to assign the operating channel to the Priority A or Priority B channel, respectively.

MEMORY CHANNELS 1, 2, 3, 4

Push to directly select memory channel 1, 2, 3 or 4, if programmed.

LONE WORKER (p. 3-13)

- ➔ Hold down for 1 second to turn ON the Lone Worker function.
 - When the Lone Worker function is turned ON, and no operation is performed for the specified time period, the Emergency function is automatically turned ON.
- ➔ Push to turn OFF the Lone Worker function.

MONITOR, MONITOR (AUDIBLE)

- ➔ Push to turn the CTCSS (DTCS) or 2/5-tone squelch Mute ON or OFF.
 - Only during LMR operation, push to open any squelch functions, or deactivate any mute functions.
 - Only during PMR operation, push to activate one or two of the following functions on each channel.
 - Hold down to unmute the channel (Audible mode).
 - Push to mute the channel (Inaudible mode).
 - Push to send a 'reset code' after the communication is finished.

 **NOTE:** The unmute condition may automatically return to the mute condition, after a specified time period.

- ➔ Depending on the presetting, holding down this key for 1 second cancels a scan.

LOCK

Hold down to electronically lock all programmable keys except [Moni(Audi)], [Call] (including Call A and Call B), [Emergency], [Surveillance] and [Lone Worker].

HIGH/LOW (p. 3-12)

Select the transmit output power level temporarily or permanently, depending on the presetting.

TALK AROUND

- ➔ Hold down for 1 second to turn ON the Talk Around function.
 - The Talk Around function equalizes the transmit frequency to the receive frequency for transceiver-to-transceiver communication.
- ➔ Push to turn OFF the Talk Around function.

DTMF AUTODIAL

Push to transmit a programmed DTMF code.

RE-DIAL

Push to transmit the last-transmitted DTMF code.

 **NOTE:** TX memories are cleared after turning OFF the transceiver.

WIDE/NARROW

Push to select the IF bandwidth between Wide, Mid* or Narrow.

*Depending on the presetting, the Mid channel width may not be selectable.

CALL, CALL A, CALL B

Push to transmit a 2/5-tone code.

- Tone call transmission may be necessary before you call another station, depending on your signalling system.
- [Call A] and/or [Call B] keys may be selectable when your system employs selective 'Individual/Group' calls.

EMERGENCY

Hold down for specified time period to transmit an emergency call.

- The emergency call transmits with beeps, and the status indicator lights red.
- The transceiver can transmit an emergency call without the beep sounding and the status indicator lighting.
- If you want to cancel the emergency call, hold down the key again before transmitting the call.
- The emergency call is transmitted one time only, or repeatedly until receiving an acknowledgement signal, or until the power is turned OFF.

When a matched 5-tone code signal is received, the emergency function can be cancelled, depending on the presetting. (PMR operation only)

Programmable function keys (Continued)

SURVEILLANCE

- Hold down for 1 second to turn ON the Surveillance function.
 - When this function is turned ON, the beep is not heard and the status indicator does not light when a signal is received, or a key is pushed.
- Push to turn OFF the Surveillance function.

SIREN

Hold down for 1 second to emit a siren sound.

This function can be used for situations other than an emergency alert, such as a security alarm for example.

The transceiver emits the siren sound until the power is turned OFF.

SCRAMBLER

- Hold down for 1 second to turn ON the Voice Scrambler function while operating in the digital mode.
- Push to turn OFF the Voice Scrambler function.

ANNOUNCE

Push to turn the Channel Announce function ON or OFF.

- When this function is turned ON, the transceiver announces the position of [ROTARY SELECTOR] between 1 and 16 when rotating [ROTARY SELECTOR] to a desired number.

Turning ON the power	3-2
Selecting a channel	3-3
◇ Selecting a channel	3-3
◇ Voting Operation.....	3-3
◇ Priority A channel selection.....	3-3
Call procedure	3-4
Receiving and transmitting	3-5
◇ Transmitting notes	3-5
◇ DTMF transmission	3-6
◇ Receiving a Stun, Kill and Revive command.....	3-6
Setting the Beep function	3-7
Setting the beep level.....	3-8
Setting the ringer level.....	3-9
Setting the microphone gain	3-10
Setting the squelch level	3-11
Output power level selection.....	3-12
Emergency Call.....	3-13
◇ Lone Worker Emergency Call.....	3-13
◇ Man Down Emergency Call.....	3-13

Turning ON the power

Prior to using the battery pack for the first time, or after not using it for a long time, you must fully charge the pack for optimum battery life and operation. See BASIC INSTRUCTIONS that are provided with the transceiver for details.

➡ Rotate [VOL] to turn ON the power.

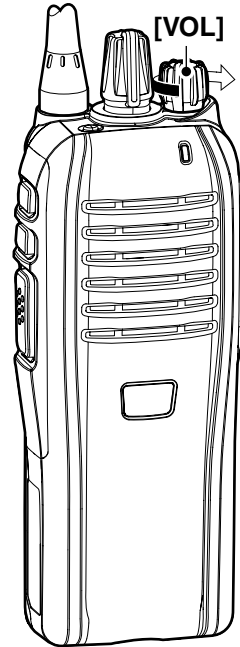

Selecting a channel

◇ Selecting a channel

To select the desired operating channel:

- Rotate [ROTARY SELECTOR].
- Push one of the memory channel keys, [MR-CH 1] to [MR-CH 4].
- Push [Prio A], [Prio B], [Prio A (Rewrite)] or [Prio B (Rewrite)].

AUTOMATIC SCAN TYPE:

Selecting a channel is not necessary. When turning ON the power, the transceiver automatically starts scanning. Scanning stops when a signal is detected.

◇ Voting Operation

The transceiver automatically starts scanning when a zone, specified for the voting operation, is selected. The voting scan detects the signal of the repeater and automatically selects the strongest station.

◇ Priority A channel selection

When one of the following operations is performed, the transceiver automatically selects the Priority A channel.

• Turning ON the power

The Priority A channel is selected each time the transceiver power is turned ON.

• Auto reset

The Priority A channel is selected when the Auto Reset timer ends.

Call procedure

When your system employs tone signalling (excluding CTCSS and DTCS), the tone call procedure may be necessary prior to voice transmission. The tone signalling that is employed in the transceiver may be a selective calling system, which allows you to call only specific station(s), and prevents unwanted stations from contacting you.

- ① Select a desired TX code channel or 2/5-tone code, according to your System Operator's instructions.
 - This may not be necessary, depending on the programming.
- ② Push [Call] (assigned to [Upper], [Lower] or [Emer]). (p. 2-6)
- ③ After transmitting a 2/5-tone code, the remainder of your communication can be carried out normally.

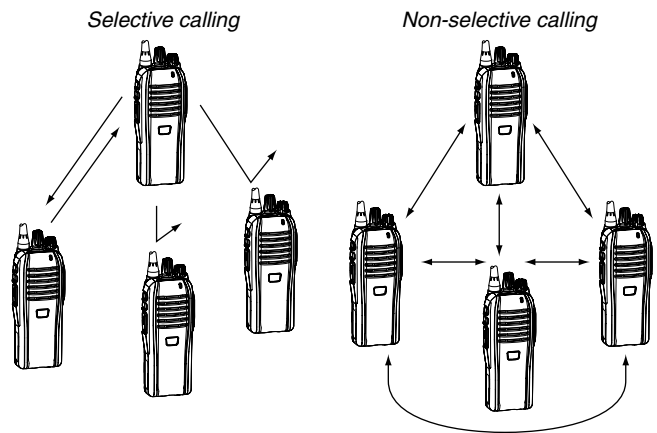

Receiving and transmitting

Receiving:

- ① Rotate [VOL] to turn ON the power.
- ② Select a channel.
 - Rotate [ROTARY SELECTOR].
 - Push one of the memory channel keys, [MR-CH 1] to [MR-CH 4].
- ③ When receiving a call, adjust the audio output to a comfortable listening level.

NOTE: When a matched RX code signal is received, the transceiver automatically transmits its microphone audio for a specified time period, depending on the presetting.

Transmitting:

CAUTION: Transmitting without an antenna will damage the transceiver. See page 1-3 for antenna attachment.

Wait for the channel to become clear to avoid interference.

- ① While holding down [PTT], speak into the microphone at a normal voice level.
- ② Release [PTT] to receive.

NOTE: To maximize the readability of your signal:
1. Pause briefly after pushing [PTT].
2. Hold the microphone 5 to 10 cm (2 to 4 inches) from your mouth, then speak at a normal voice level.

◇ Transmitting notes

• Transmit inhibit function

The transceiver has several inhibit functions, which restrict transmission under the following conditions:

- The channel is muted. (PMR operation only)
- The channel is busy.
- A signal with an unmatched (or matched) CTCSS (or DTCS) tone is received.
- The selected channel is a 'receive only' channel.

• Time-out timer

After continuously transmitting longer than the preprogrammed time period, the time-out timer activates, and stops further transmitting.

• Penalty timer

Once the time-out timer activates, transmitting is further inhibited for a time period determined by the penalty timer.

• PTTID call

The transceiver automatically sends the ID code (5-tone, DTMF or BIIS operations) when [PTT] is pushed (beginning of the transmission) and/or released (end of transmission), depending on the presetting.

Receiving and transmitting (Continued)

◇ **DTMF transmission**

If the transceiver has [DTMF Autodial] assigned to it, the automatic DTMF transmission function is usable.

➔ Push [DTMF Autodial] to transmit the DTMF code.

◇ **Receiving a Stun, Kill and Revive command**

The dispatcher can send a signal that will stun, kill or revive your transceiver.

When the Stun command is received, a beep sounds*, and the transceiver becomes unusable. Receiving a Revive command is necessary to operate the transceiver again in this case.

When the Kill command is received, a beep sounds*, and the transceiver becomes unusable. Cloning the transceiver is necessary to operate the transceiver again in this case.

* Depending on the presetting.

Setting the Beep function

The Beep function can be turned ON or OFF. When it is OFF, the channel announcement is also turned OFF.

NOTE: You should turn ON the Beep function when you set the microphone gain or the squelch level to check the current level setting with the beep sounding. (pp. 3-10, 3-11)

- ① Rotate [VOL] to turn OFF the transceiver power.
- ② Set [ROTARY SELECTOR] to any channel other than Channel 16.
- ③ While holding down [Lower], rotate [VOL] to turn ON the power to enter the Beep level adjustment mode.
- ④ Push [Lower] to turn the Beep function ON or OFF.
 - When a beep sounds after pushing [Lower], the Beep function is ON. When no beep sounds after pushing [Lower], the Beep function is OFF.
 - If desired, push [Upper] to adjust the Beep level. See page 3-8 for details.
- ⑤ Rotate [VOL] to turn OFF the power to exit the Beep level adjustment mode.

NOTE: This operation may not be available, depending on the presetting.

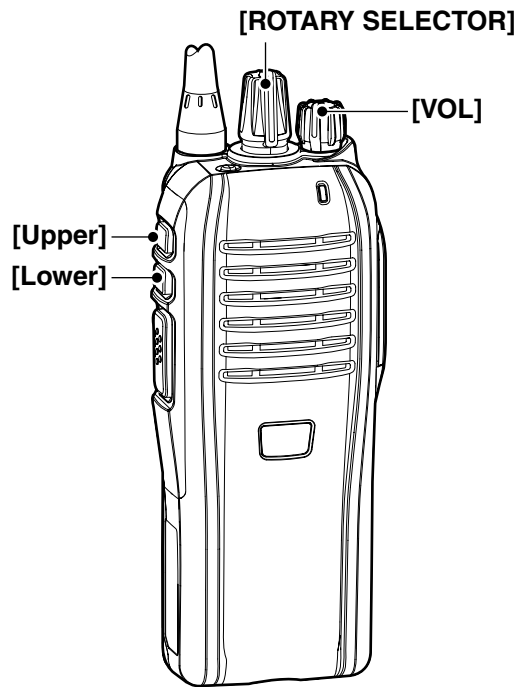

Setting the beep level

You can adjust the beep level between 1 and 5, or 1 (linked) and 5 (linked).

When a linked option is selected, you can adjust the beep level by rotating [VOL].

- ① Rotate [VOL] to turn OFF the transceiver power.
- ② Set [ROTARY SELECTOR] to any channel other than Channel 16.
- ③ While holding down [Lower], rotate [VOL] to turn ON the power and enter the beep level adjustment mode.
- ④ Push [Upper] to change the beep level as shown to the right.
 - A beep sounds every time you push [Upper]. Therefore, you can determine the current level setting by the increasing loudness of the beep that sounds.
 - To determine if you have selected a linked level, set [VOL] to minimum, then push [Upper] repeatedly, listening for the loudest beep (level 5). Pushing [Upper] once after the loudest beep will select 1 (Linked). Repeatedly push [Upper] to select the desired linked level.
- ⑤ Rotate [VOL] to turn OFF the power to exit the beep level adjustment mode.

/// **NOTE:** This operation may not be available, depending on the presetting.

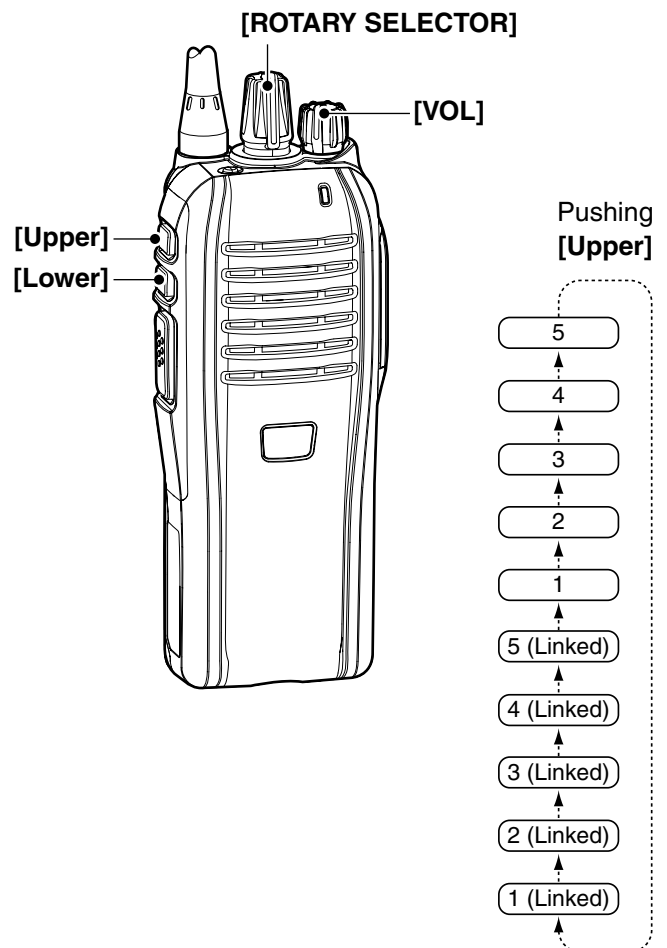

Setting the ringer level

You can adjust the ringer level between 1 and 5, or 1 (linked) and 5 (linked).

When a linked option is selected, you can adjust the ringer level by rotating [VOL].

- ① Rotate [VOL] to turn OFF the transceiver power.
- ② Set [ROTARY SELECTOR] to Channel 16.
- ③ While holding down [Lower], rotate [VOL] to turn ON the power and enter the ringer level adjustment mode.
- ④ Push [Upper] to increase, or push [Lower] to decrease the ringer level as shown to the right.
 - A beep sounds after pushing [Upper] or [Lower]. Therefore, you can determine the current level setting by the increasing loudness of the beep that sounds.
 - To determine if you have selected a linked level, set [VOL] to minimum, then push [Upper] up to 10 times, listening for the loudest beep (level 5). Pushing [Upper] once after the loudest beep will select 1 (Linked). Repeatedly push [Upper] or [Lower] to select the desired linked level.
- ⑤ Rotate [VOL] to turn OFF the power to exit the ringer level adjustment mode.

/// **NOTE:** This operation may not be available, depending on the presetting.

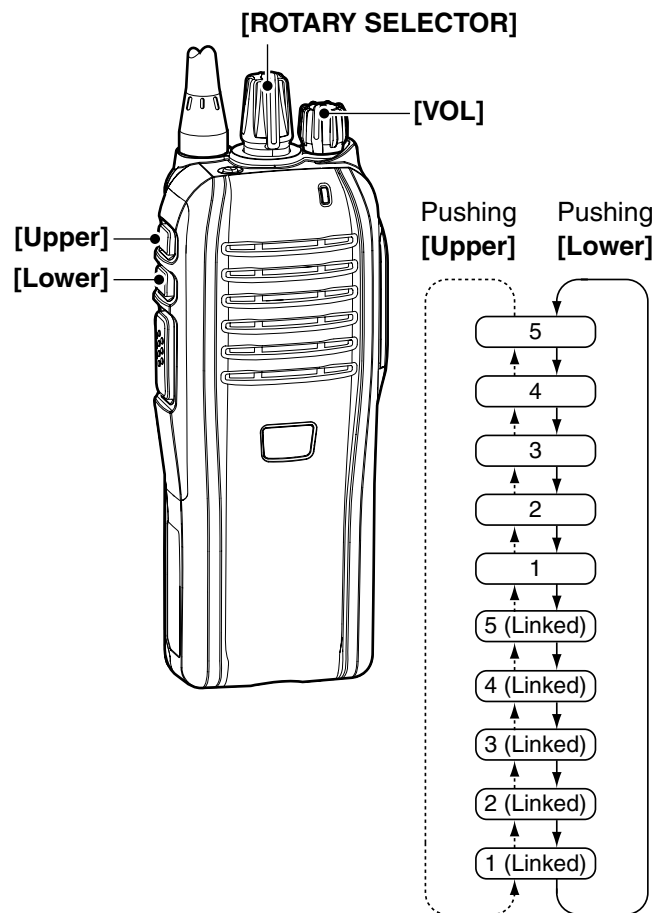

Setting the microphone gain

Higher levels make the microphone more sensitive to the user's voice.

- ① Rotate [VOL] to turn OFF the transceiver power.
- ② Set [ROTARY SELECTOR] to Channel 16.
- ③ While holding down [Upper], rotate [VOL] to turn ON the power and enter the microphone gain adjustment mode.
- ④ Push [Upper] or to increase, or push [Lower] to decrease the microphone gain.
 - The adjustable range is 1 (minimum) to 4 (maximum).
 - A beep sounds after pushing [Upper] or [Lower].
An error beep sounds if you try to exceed the adjustable range.
- ⚡ **NOTE:** The Beep function should be turned ON. (p. 3-4)
- ⑤ Rotate [VOL] to turn OFF the power to exit the microphone gain adjustment mode.

⚡ **NOTE:** This operation may not be available, depending on the presetting.

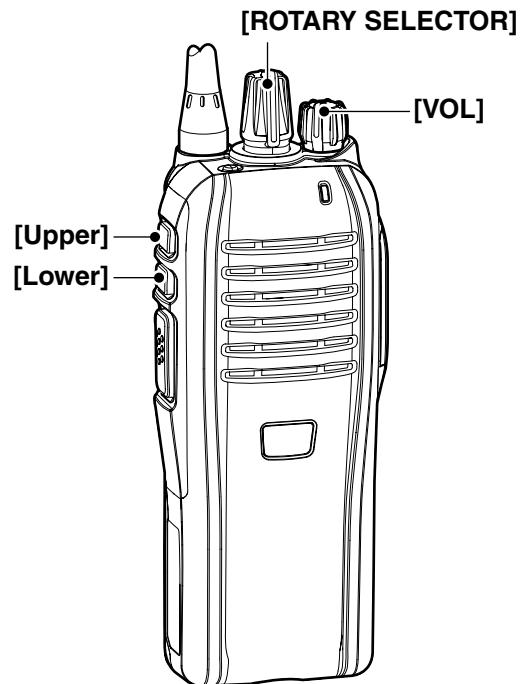

Setting the squelch level

The squelch circuit mutes the received audio signal, depending on the signal strength.

- ① Rotate [VOL] to turn OFF the transceiver power.
- ② Set [ROTARY SELECTOR] to any channel other than Channel 16.
- ③ While holding down [Upper], rotate [VOL] to turn ON the power and enter the squelch level adjustment mode.
- ④ Push [Upper] to increase the squelch level (tight squelch), or push [Lower] to decrease the squelch level (loose squelch).
 - The adjustable range is 0 (loose squelch) to 9 (tight squelch).
 - A beep sounds after pushing [Upper] or [Lower]. An error beep sounds if you try to exceed the adjustable range.
- ⚡ **NOTE:** The Beep function should be turned ON. (p. 3-4)
- ⑤ Rotate [VOL] to turn OFF the power to exit the squelch level adjustment mode.

⚡ **NOTE:** This operation may not be available, depending on the presetting.

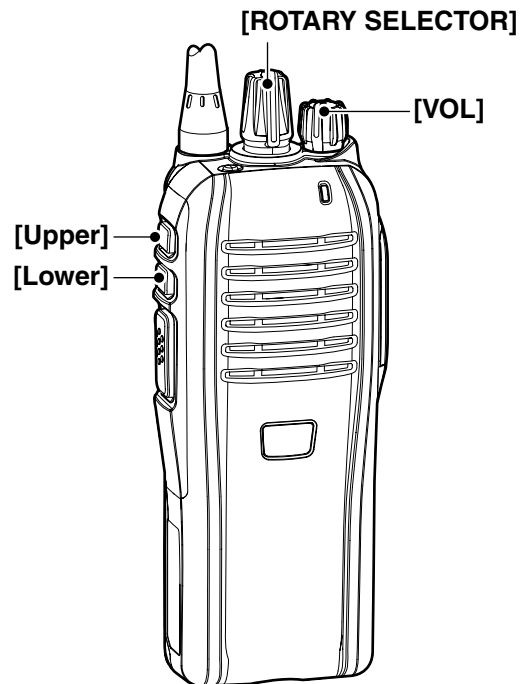

Output power level selection

If the transceiver has [High/Low] assigned to it, the transmit output power level can be selected, depending on the presetting.

When the battery voltage drops to a low power level and the status indicator indicates “Low Battery 2,” the output power automatically switches to “Low 1.” (p. 2-3)

➡ Push [High/Low] to select the transmit output power level.

- One beep sounds when “Low 1” is selected.
- Two beeps sound when “Low 2” is selected.
- Three beeps sound when “High” is selected.

Emergency Call

When [Emergency] is held down for the specified time period*, the emergency signal is transmitted once, or repeatedly, on the specified emergency channel.

* Depending on the presetting.

A repeat emergency signal is automatically transmitted until you turn OFF the power.

Depending on the preprogrammed settings, receiving a matching 5-tone code cancels the transmission. When no emergency channel is specified, the signal is transmitted on the previously selected channel.

If you want to cancel the emergency call, hold down [Emergency] again before transmitting the call. If your transceiver is programmed for Silent operation, you can transmit an Emergency call without the beep sounding and the status indicator lighting.

IMPORTANT: We recommend you set an emergency channel individually to provide for reliable emergency call operation.

NOTES

Depending on the presetting, the following functions are automatically activated.

• Auto TX function

After the emergency call transmission, audio from the microphone is automatically transmitted for a specified time period.*

• Auto RX function

After the emergency call transmission, the transceiver stands by in the Audible mode for the specified time period.*

* Depending on the presetting.

◇ Lone Worker Emergency Call

When the Lone Worker function is turned ON, and no operation is performed for the specified time period*, the transceiver enters the emergency mode, and then the countdown for the emergency call transmission starts.

After the specified time period* has passed, an emergency call is automatically transmitted once, or repeatedly*.

If someone operates the transceiver before the call is transmitted, the transceiver exits the emergency mode, and the emergency call is cancelled.

* Depending on the presetting.

- ① Hold down [Lone Worker] for 1 second to turn ON the Lone Worker function.
- ② Push [Lone Worker] to turn OFF the Lone Worker function.

◇ Man Down Emergency Call

When the transceiver has been left in a horizontal position for the preprogrammed time period, the transceiver enters the emergency mode, and then the countdown for the emergency call transmission starts.

After the preprogrammed time period, an emergency call is automatically transmitted once, or repeatedly, depending on the pre-programmed settings.

If the transceiver is placed in a vertical position before the first transmission, the transceiver exits the emergency mode and the emergency call is cancelled.

dPMR™ operation.....	4-2
Receiving a call.....	4-3
◇ Receiving an Individual call	4-3
◇ Receiving a Group call	4-3
◇ Receiving a Stun, Kill or Revive	4-3
◇ Receiving a Status Polling call	4-3
◇ Receiving an Ambience Listening call.....	4-3
◇ Receiving an Emergency call	4-3
◇ Talk back function.....	4-3
Transmitting a call	4-4
◇ Transmitting a Voice call	4-4
◇ Transmitting an Emergency call	4-4
Status message transmission.....	4-5
Scrambler function.....	4-6

dPMR™ operation

The transceiver providing digital Private Mobile Radio (dPMR™) operation meets the 6.25 kHz bandwidth requirements for narrow band operation. This increases the efficiency of channel allocation and use of the spectrum.

/// **NOTE:** During dPMR™ operation, BISS 1200 operation is disabled.

Receiving a call

◇ Receiving an Individual call

- ① When an Individual call is received:
 - The transceiver will automatically transmit a return signal.
 - The status indicator blinks orange.
 - Beeps sound and the mute is released.
- ② Hold down [PTT], then speak into the microphone.
- ③ Release [PTT] to receive.
- ④ After the communication is finished, push [Clear] to send a 'Disconnect' signal to terminate the connection.

/// **NOTE:** The status indicator and Beeps may differ, depending on the presetting.

◇ Receiving a Group call

- ① When a Group call is received:
 - The status indicator blinks orange.
 - Beeps sound and the mute is released.
- ② Hold down [PTT], then speak into the microphone.
 - /// **NOTE:** Only one station is allowed to speak at the same time.
- ③ Release [PTT] to receive.
- ④ After the communication is finished, push [Clear] to send a 'Disconnect' signal to terminate the connection.

/// **NOTE:** The status indicator or Beeps may differ, depending on the presetting.

◇ Receiving a Stun, Kill or Revive

If an individual Stun or Kill call is received, the transceiver will automatically transmit an acknowledgement, and then you cannot receive* or transmit.

*Reception may be available, depending on the presetting of the received stun command.

- ➔ When a Stun command is received:
 - The transceiver cannot be operated until the individual revive call is received or until data cloning is performed.
 - Even if [ROTARY SELECTOR] is changed, the transceiver will stay on the same channel the Stun command received on.
- ➔ When a Kill command is received:
 - The status indicator alternately blinks red and green.
 - The transceiver cannot be operated until data cloning is performed.

/// **NOTE:** Depending on the presetting, the transceiver may ignore the Stun, Revive and Kill commands, that are from a non-specified station.

◇ Receiving a Status Polling call

If a Status Polling call is received, the transceiver will automatically transmit its current status.*

◇ Receiving an Ambience Listening call

If an Individual call with an Ambience Listening command is received from a specified station, the transceiver will automatically transmit its microphone audio.*

*Depending on the presetting.

/// **NOTE:** If the transceiver receives an Ambience Listening command from a station other than the specified one, the call will be ignored, and the transceiver will not transmit its microphone audio.

◇ Receiving an Emergency call

- ① When an Emergency call is received:
 - The transceiver will automatically transmit a return signal.
 - The status indicator blinks orange.
 - Beeps sound and the mute is released.
- ② Push [Clear] to return to the standby mode.

◇ Talk back function

The Talk Back function allows you to select the same call mode (Analog or Digital) as the received call.

/// **NOTE:** When this function is not activated, the transceiver always transmits analog signals on "Mixed-Analog" channels, and digital signals on "Mixed-Digital" channels.

/// • On these channels, the transceiver can receive both analog and digital signals, regardless of the Talk Back function.

Transmitting a call

dPMR™ operation allows you to make a call to a specific station (Individual call) or to a particular group (Talkgroup call). Other digital mode transceivers on the channel will not receive a call that does not match their individual or talkgroup ID and/or CC.

◇ Transmitting a Voice call

- ① Rotate [ROTARY SELECTOR], or push one of the memory channel keys, [MR-CH 1] to [MR-CH 4], to select a desired channel, Individual ID or Talkgroup ID, depending on the presetting.
- ② Push [PTT] or [Call] to make a Voice call.
 - The status indicator lights red while transmitting.
 - The status indicator fast blinks orange.
 - After an acknowledgement is received, the status indicator slowly blinks orange in the Audible mode, or it goes OFF when no acknowledgement is received.
- ③ Hold down [PTT], then speak at your normal voice level.
 - The status indicator lights red while transmitting.
- ④ Release [PTT] to receive.
- ⑤ After you finish your communication, push [Clear] to send a 'Disconnect' signal to terminate the connection.

◇ Transmitting an Emergency call

When [Emergency] is held down for the specified time period, the emergency signal (digital command) is transmitted once or repeatedly* on the specified emergency channel. When no emergency channel is specified, the signal is transmitted on the operating channel.

* When the Repeat Cancel function is ON, the transceiver cancels repeating after receiving a return signal.

When the Repeat Cancel function is OFF, the transceiver repeats calling according to the number of repeat cycles, even after receiving a return signal.

Individual or Talkgroup call types of emergency calls can be pre-set. If the call type is not preset, the default or selected call type is used.

If you want to cancel the emergency call, hold down [Emergency] again before transmitting the call.

If your transceiver is programmed for Silent operation, you can transmit an Emergency call without the beep sounding and the status indicator lighting.

The transceiver can also be programmed to keep the microphone open during an emergency call, so others can monitor the situation.

IMPORTANT: We recommend you set an emergency channel individually to provide the certain emergency call operation.

NOTE: If the Digital Request Ack function is activated, the transceiver transmits the emergency call with a request to send back a return signal.

Status message transmission

The status message can automatically be transmitted. The status message is transmitted when the transceiver is turned ON or OFF.

- Select a status message to be transmitted in 'Power ON Status' or 'Power OFF Status' items, respectively.
- Select a target station ID in 'Power Status ID'.

Scrambler function

The voice scrambler function provides private communication between stations while operating in the digital mode.

- ① Hold down [Scrambler] for 1 second to turn ON the Scrambler function.
- ② Push [Scrambler] to turn OFF the Scrambler function.

Section 5

SPEAKER MICROPHONE

Optional HM-203EX	5-2
◇ Description	5-2
◇ To attach.....	5-2

Optional HM-203EX

◇ Description

/// **NEVER** immerse the connector in water. If the connector becomes wet, be sure to dry it **BEFORE** connecting it to the transceiver.

/// **NOTE:** The microphone is located at the top of the speaker microphone, as shown in the diagram above. To maximize the readability of your transmitted signal (voice), hold the microphone approximately 5 to 10 cm (2 to 4 inches) from your mouth, and speak at a normal voice level.

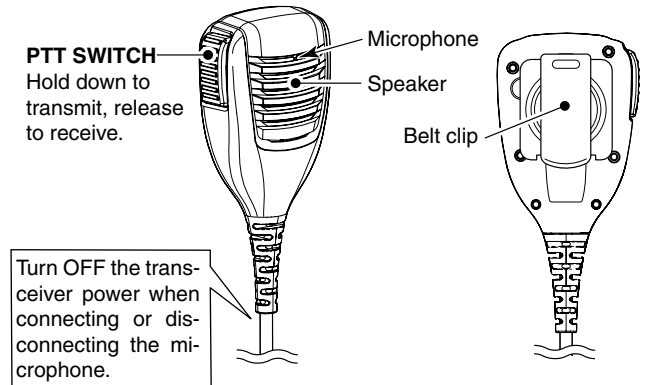

◇ To attach

/// **BE SURE** to turn OFF the power before attaching.

➔ Attach the connector of the speaker microphone into the multi connector on the transceiver, and tighten the screw.

/// **IMPORTANT: KEEP** the connector cover attached to the transceiver when the speaker microphone is not in use. (p. 1-4)
Water will not get into the transceiver even if the cover is not attached, however, the terminals (pins) will become rusty, or the transceiver will function abnormally if the connector becomes wet.

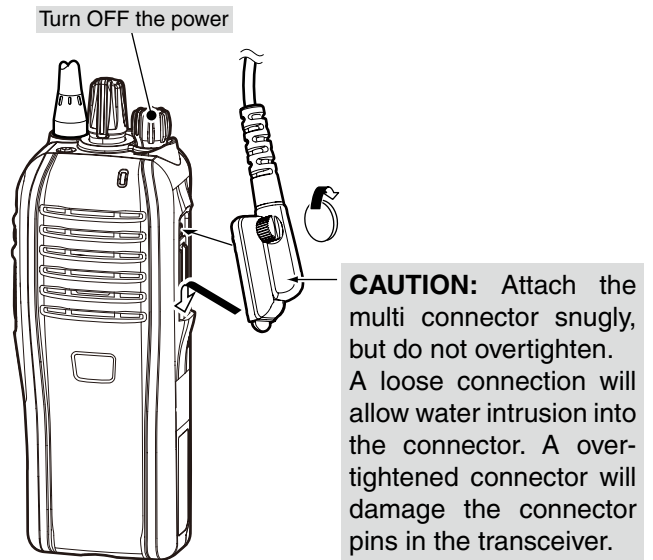

Count on us!

